



Product Data Sheet (2018-09-02)

28446 - Flexbalance hydraulic separator 150F



Description	Flexbalance hydraulic separator 150F	
Article	28446	
Model	FlexBalance F	
Capacity [l]	336	
Connection	DN	150
	D [mm]	168.3
Capacity [kW] *	1000 - 1750	
Flow in the system [m ³ /h]	55 - 120	
K _v ** [m ³ /h] (ΔP = 1 bar)	775	
Weight [kg]	180	

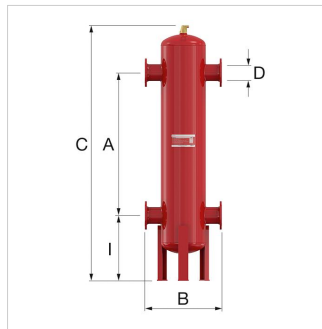
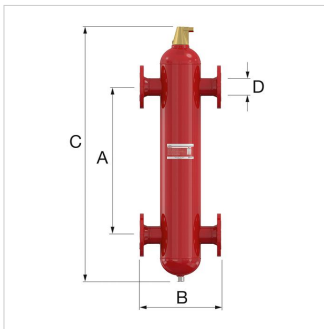

Packaging info

Unity of use	1 Piece
Packaging form	Crate
Packaging dimensions (H. x W. x L.)	690 x 890 x 2700 mm
Weight	180 Kilogram



Classification General Data

Etim Group	Distributors/collectors
Etim Class	Open CH distributor
Product Name	Flexbalance hydraulic separator 150F
Brand	Flamco
Product Series	Flexbalance 50-200 R
Product Type	150

Attributes

Material	Steel
Surface protection	Powder coating
Max. heating power [kW]	1750
Number of boiler connections	2
Boiler connection model	Flange
Nominal inner diameter, boiler connections	Other
Installation side connection model	Flange
Nominal inner diameter, installation side	Other
Nominal inner diameter, shunt pipe	Not applicable
Number of air-release connections	1
Nominal inner diameter, air-release	1/2" inside

Type	Dimensions					
	A [mm]	B [mm]	C [mm]	E [mm]	H [mm]	I [mm]
FlexBalance F 50	490	350	900	88	154	
FlexBalance F 65	635	350	1045	88	154	
FlexBalance F 80	745	470	1340	135	188	
FlexBalance F 100	965	470	1585	135	188	
FlexBalance F 125	1180	635	2065	180	213	
FlexBalance F 150	1430	774	2585	225	237	655
FlexBalance F 200	1860	1000	3355	300	277	825

Flamco Group
 Amersfoortseweg 9
 3751 LJ, Bunschoten - nl
T +31 33 299 75 00
F +31 33 298 64 45
E info@flamcogroup.com
I flamcogroup.com